

# The Portable Three-Axis Mill

12970 Branford St. Unit M, Arleta CA 91331 Phone 1-800-480-6427  
 Email: [microfence@microfence.com](mailto:microfence@microfence.com) Website: [www.microfence.com](http://www.microfence.com)



The **Micro Fence® Portable Three-Axis Mill** brings the ultimate scalpel-like control to your routing!

We bring you thousandth-of-an-inch (or twentieth-of-a-millimeter with our metric version), control in the vertical axis for maximum depth-of-cut control.

Used with the **Micro Fence® Edge Guide**, you'll have all the elements of a precision milling machine.

The **Portable Three-Axis Mill** is compatible with all existing **Micro Fence®** products and accepts several brands of laminate trimmer motors.

## TABLE OF CONTENTS 3/1/06

Parts Diagram .....	2
Packing List.....	3
Getting Started .....	4
Operation .....	4
The Turret: .....	5
Depth-of-Cut Setting.....	5
Optional 6 LED Light Ring.....	6
Plunge Base Lower Plate (Part #80): Hole Configuration.....	7
Clear Acrylic 6" Sub-Base (Part #91): Hole Configuration.....	7
Features .....	8
Cleaning and Maintenance.....	8
The Ball-Tip Allen Screwdriver .....	9
Reading Recommendations .....	10

## Parts Diagram

We suggest that you take a few moments to familiarize yourself with the names of our parts by referring to the drawing below. We'll be referring to these numbers throughout these instructions.

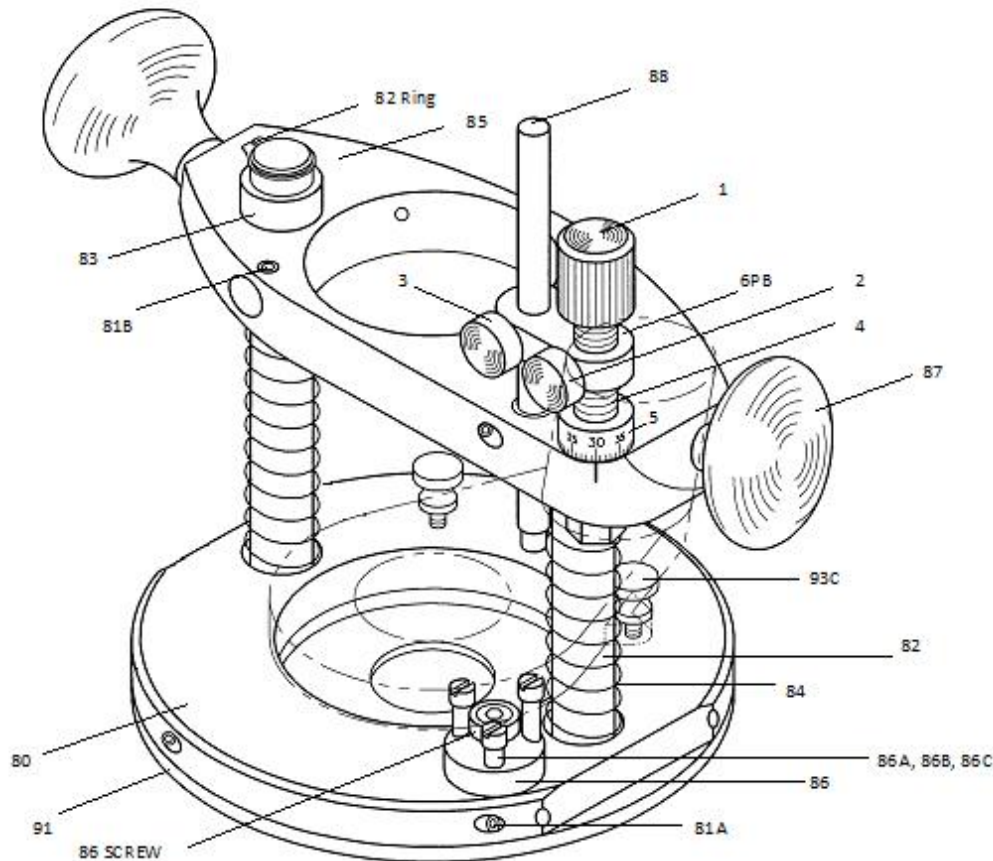

- |        |                                          |          |                                    |
|--------|------------------------------------------|----------|------------------------------------|
| 1      | Aluminum Knob                            | 84       | Plunge Springs (2)                 |
| 2      | Brass Thumbscrew (Short)                 | 85       | Motor Carriage                     |
| 3      | Brass Thumbscrew (Med.)                  | 86       | Plunge Base Turret                 |
| 4      | Lead Screw                               | 86-SCREW | Turret Center Screw                |
| 5      | Micrometer Dial                          | 86A      | Turret Post - 1/4"                 |
| 6PB    | Plunge Spindle Bar                       | 86B      | Turret Post - 3/8"                 |
| 80     | Plunge Base Lower Plate                  | 86C      | Turret Post - 1/2"                 |
| 81A    | 1/4-20 x 1/2" Brass-Tipped Set Screw (5) | 87       | Plunge Locking Handle (right side) |
| 81B    | 1/4-20 x 1/4" Nylon-Tipped Set Screw (4) | 88       | 5/16" Plunge Stop Rod              |
| 81D    | 1/4-20 x 3/8" Brass-Tipped Set Screw (2) | 91       | Acrylic 6" Sub-Base                |
| 82     | Stainless Post (2)                       | 93C      | Alum Dust Hood Thumbscrew          |
| 82RING | Retaining Ring (2)                       |          |                                    |
| 83     | Bronze Bushing (2)                       |          |                                    |

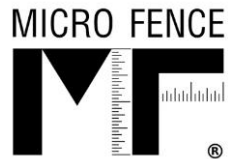

# The Portable Three-Axis Mill

12970 Branford St. Unit M, Arleta CA 91331 Phone 1-800-480-6427  
 Email: [microfence@microfence.com](mailto:microfence@microfence.com) Website: [www.microfence.com](http://www.microfence.com)

## Packing List

The photo below shows the standard accessories that are included with your mill. Your **Micro Fence®** Plunge Base includes all of the numbered call-outs in the photograph below.

Not shown is the optional Mounting Bar that adapts any **Micro Fence®** Edge Guide or Circle Jig for use on the plunge base. If you already own one of our Edge Guides to fit another router, you will need the Plunge Base mounting bar. If you are new to our system and just now purchasing your Edge Guide to fit the plunge base, the mounting bar will be included with it.

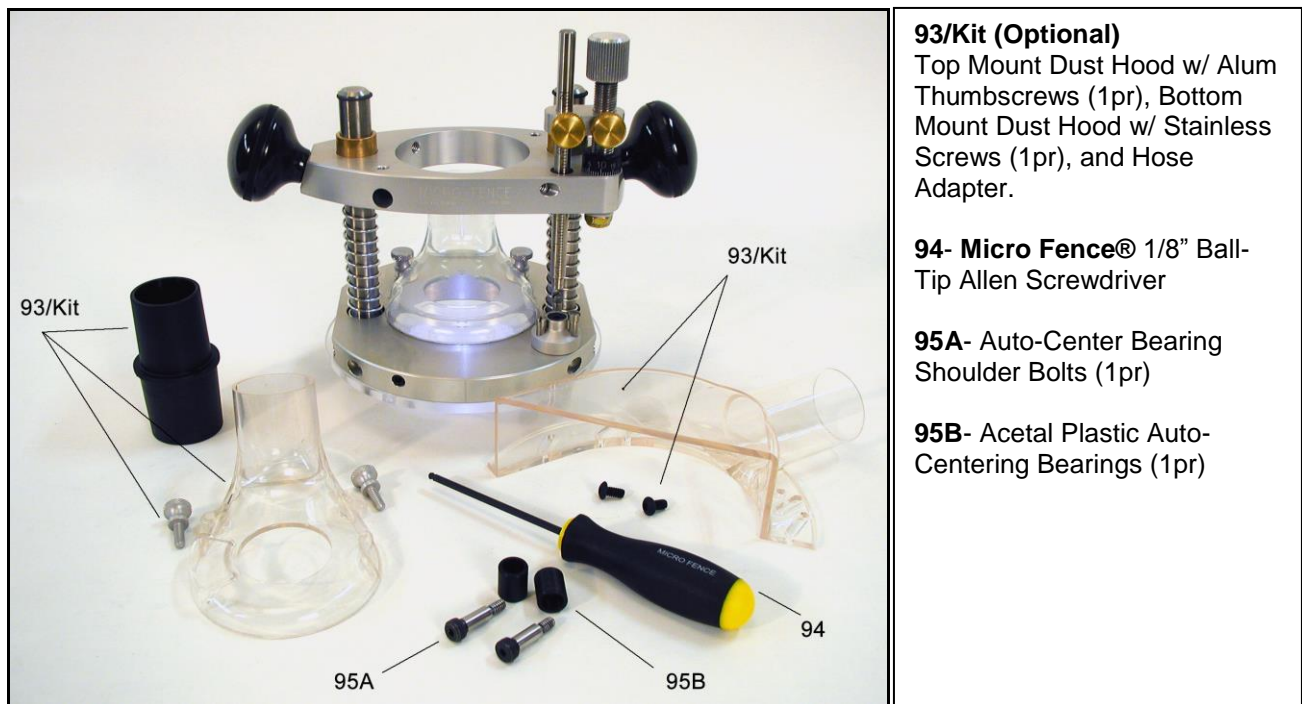

- 93/Kit (Optional)**  
 Top Mount Dust Hood w/ Alum Thumbscrews (1pr), Bottom Mount Dust Hood w/ Stainless Screws (1pr), and Hose Adapter.
- 94- Micro Fence® 1/8" Ball-Tip Allen Screwdriver**
- 95A- Auto-Center Bearing Shoulder Bolts (1pr)**
- 95B- Acetal Plastic Auto-Centering Bearings (1pr)**

All **Micro Fence®** System components can be used with your Portable Three-Axis Mill. The **Micro Fence®** Edge Guide, Circle Jig, Ellipse Jigs, and all other accessories are completely compatible.

## Optional Accessories:

- Top & Bottom Dust Hood Kit w/Hose Adapter
- **Micro Fence®** Edge Guides, Circle & Ellipse Jigs
- Adapter Sleeves for Different Trimmer Motors
- Center Bar & Leveler Kits (existing MF accessory)
- Our 6 LED Light Ring Assembly
- 1 3/4" Throat Clear Acrylic Base
- Precision Template Guide Bushing Sub-base
- Precision Template Guide Bushings
- Metric Conversion Kit

## Specifications:

- 6" Dia. Base
- Compatible w/PC Temp. Guide Bushings
- Wt: 3.85 lbs, 5.07 lbs w/Edge Guide
- Vertical Adjustment to .001"
- Overall Vertical Travel 2.75"

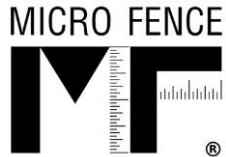

# The Portable Three-Axis Mill

12970 Branford St. Unit M, Arleta CA 91331 Phone 1-800-480-6427  
Email: [microfence@microfence.com](mailto:microfence@microfence.com) Website: [www.microfence.com](http://www.microfence.com)

## Getting Started

Your Portable Three-Axis Mill has been thoroughly tested at our factory for all pertinent tolerances and operation. You can simply install your choice of laminate trimmer motor and you'll be ready to start routing.

The MF Ball-Tip Allen driver fits virtually all removable parts on the mill. Use it to secure the motor in the Motor Carriage (#85). Once squarely seated, the 1/2" brass-tipped allen set-screws can be firmly tightened to secure the motor from two opposing directions. Position the motor in a posture that will not allow contact between any portion of the motors housing with the stainless posts during the plunge motion.

## Operation

We assume, since you have purchased this tool, you probably already have considerable background information regarding routing and/or plunge routing. Though we won't be discussing much routing technique or method in these instructions, we have compiled a reading list, comprised mostly by authors that are friends of ours and **Micro Fence**® users themselves. See our "Recommended Reading" bibliography (on page 10), where you'll find a wealth of knowledge on routing and related subjects.

There are a few general rules specific to this particular plunge base that we think you'll find useful. First and foremost, the micrometer dial will affect the depth-of-cut in the following manner. Please memorize this.

Turning **Counter-Clockwise**  
Makes the Cut More **Shallow**

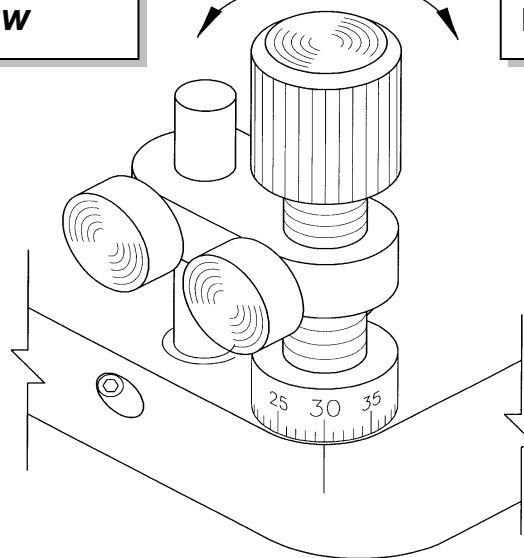

Turning **Clockwise**  
Makes the Cut **Deeper**

## The Turret:

The three-position turret indexes on a spring-loaded ball to seat the precision-machined, stainless steel stops. Once the router bit is “zeroed” at the work surface, they supply precision 1/8” increments ( $\pm .0015$ ). A laser-etched stop rod, (marked to 4”), limits your depth of cut as it contacts the turret stops. Quick and coarser depth measurements can be set with this rod. Remember that the first 1” mark *includes* the 1/4” turned-down portion of the rod as seen in the photo below.

## Example of rough depth-of-cut setting:



If you wanted to set a depth of cut that was approximately 1/2” deep, start by “zeroing” the micrometer dial (#5) at 50 and loosening the stop rod thumbscrew (#3). Descend the motor carriage (#85) via plunge, until the cutter contacts the work surface, then lock the motor carriage using the right locking handle.

Bring the stop rod down to contact the turret post of your choice. Note the mark that is visible just above the motor carriage where the stop rod enters the black plastic bushing it travels through. Raise the stop rod the desired 1/2” (on the laser-etched scale), and re-lock the brass thumbscrew (#3). Release the right locking handle and you’re ready to ‘take the plunge’.

**If you wish to further fine-tune**, measure the result of the initial cut in your work piece with a dial caliper and determine what alteration is needed in thousandths-of-an-inch (or in millimeters). The micrometer lead-screw can be used to adjust in the appropriate direction to any tolerance you prefer...be sure to allow sufficient clearance for expansion, contraction or glue.

## Depth-of-Cut Setting

Another method of setting depth-of-cut appropriate for any type of work is to use the material itself as a gauge. In the example shown in the photo here, the micrometer dial is pre-set at 50 (or zero on the metric dial), the stop rod locking thumbscrew (#3) is loosened, and the motor carriage is lowered until the router bit contacts the work surface. After locking the motor carriage in this position, a sample of the material (inlay shown here), you’re working with is placed between the turret stop and the stop rod to set the appropriate depth-of-cut. The micrometer lead screw can then be used, (in a **counter-clockwise** direction), to make the channel that will be routed .002-.004 **more shallow**. This will allow for a minimum amount of finish sanding to produce an absolutely flush installation of the inlay. (The same philosophy holds true for hinges, locks and striker plates, shelf standards, sliding door tracks, or any other job where a sample of the material being worked with is available).



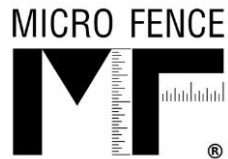

# The Portable Three-Axis Mill

12970 Branford St. Unit M, Arleta CA 91331 Phone 1-800-480-6427  
Email: [microfence@microfence.com](mailto:microfence@microfence.com) Website: [www.microfence.com](http://www.microfence.com)

## Optional 6 LED Light Ring

The Optional **Micro Fence®** LED Light Ring provides unprecedented clarity in the work area and can be easily mounted under the motor carriage. The ring utilizes six bright LED surface-mounted lights that illuminate the work area with shadow-free light. The unit comes with a 12V wall-plug converter, 10' power cord and all you'll need to install the unit. We've done considerable testing and found the light ring capable of standing up to the rigors of routing vibration and wood dust.

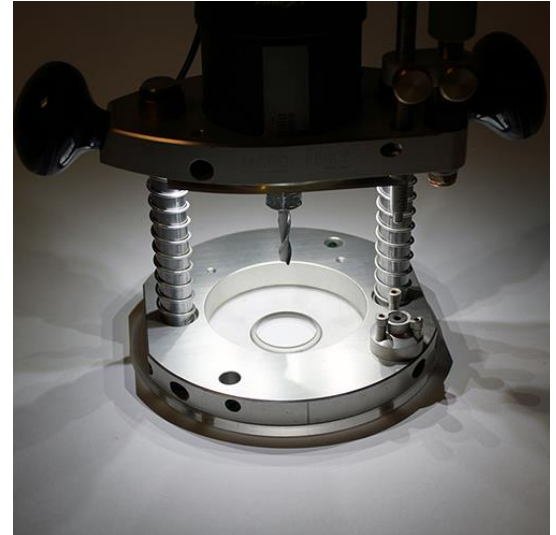
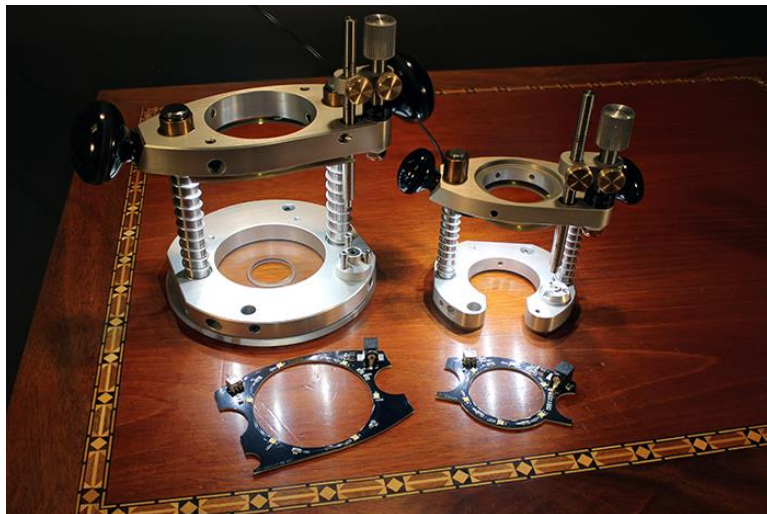

## Auto-Centering Bearings

Each 'Portable Mill' comes with a pair of shoulder bolts and two black plastic sleeves that act as bearings when they are installed on the bottom of the mill's base. The distance between the bearings is 5.015" so that materials up to 5" can be accommodated. Simply pivot the router base until both bearings have contacted the sides of the work-piece and the router bit will be automatically centered. This is especially handy when centered mortises are required and the bit diameter is proper for the size of tenon being used. In fact, any 'centered' cut can be accomplished without any measurement whatsoever.



## Plunge Base Lower Plate (Part #80): Hole Configuration

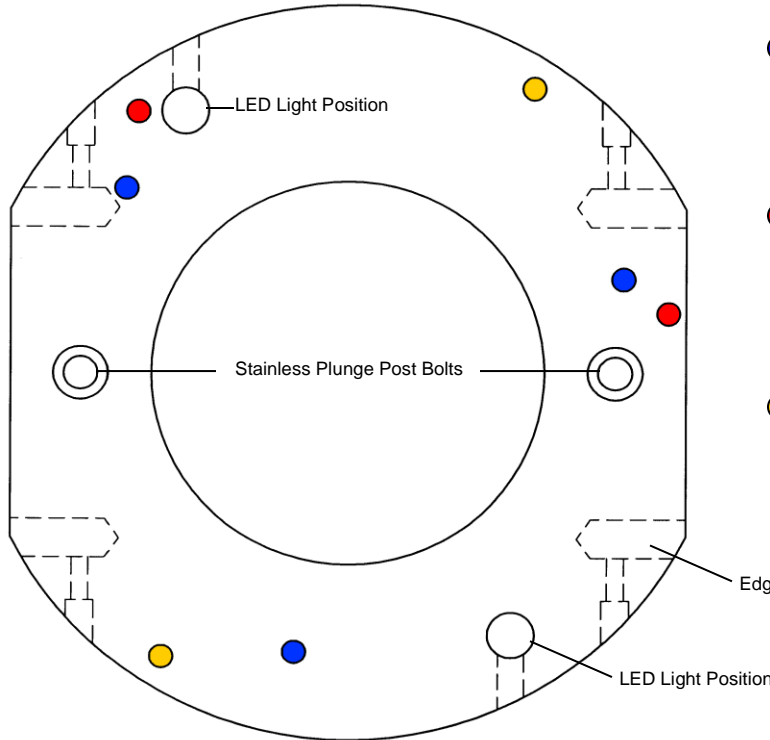

● 10-24 Threaded Holes for 6" Acrylic Plastic Sub-Base

● 10-24 Threaded Holes for Bottom Dust Hood (use button-head stainless screws provided)

● 10-24 Threaded Holes for Auto-Center Bearing Shoulder Bolts

Edge Guide Mounting Hole TYP.

LED Light Position

## Clear Acrylic 6" Sub-Base (Part #91): Hole Configuration

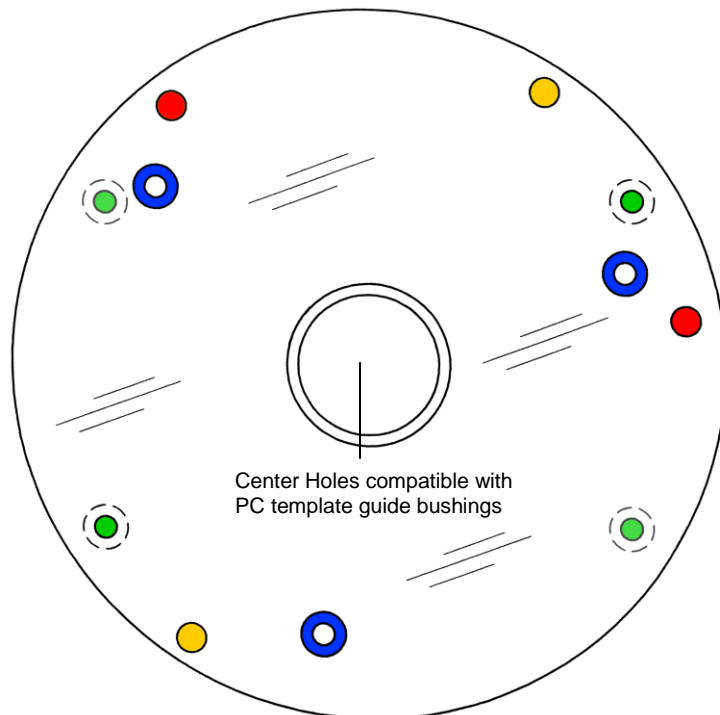

● Counter-Sunk Through Holes for 10-24 X 1/2" Flat Head Stainless Screws.

● Through Holes for Auto-Centering 10-24 Shoulder Bolts

● Through Holes Counter-Sunk from reverse side for Outboard Levelers (Center Bar & Leveler Kits).

● Through Holes for Bottom Dust Hood.

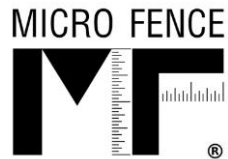

# The Portable Three-Axis Mill

12970 Branford St. Unit M, Arleta CA 91331 Phone 1-800-480-6427  
Email: [microfence@microfence.com](mailto:microfence@microfence.com) Website: [www.microfence.com](http://www.microfence.com)

## Features

- Motor Carriage Accepts Laminate Trimmer Motors:
  - Comes bored to fit the Bosch PR10/20, and with the addition of appropriate adapter rings or sleeves, will accommodate Bosch 1608, PC 310, DeWalt 670, Makita 3707, Rigid 2400, Trend T3 & T4, almost any Dremel, Proxxon IB/E and RotoZip RZ1 motors
- Precision-Ground Hard Chrome Plate & Bronze Bushing Plunge Mechanism
- 2.75" Vertical Travel – (Depth Adjustment to .001", or in millimeters)
- Dial available for imperial or metric measurement
- Concentric Collet-to-Base Positioning with 90° Scribed Base and Clear Acrylic Sub-Base compatible with PC template guide bushings
- One-Handle Plunge-Lock Mechanism
- Three-Position Precision-Indexing Turret (1/8" increments) with Stainless Steel Stops
- 90° Scratch Lines at Four Positions on Mill Base
- Laser-Marked Stainless Steel Stop Rod for Gross Adjustment
- Top and Bottom Dust Collection Hoods
- Right and Left Edge-Guide Mount Positions  
(for left or right-hand operation or operations where opposing fences are beneficial)
- Auto-Center Locating Bearings for Mortising Operations
- Single Ball-Tip Allen Wrench Driver for all Locking Screws
- 100% Non-Corrosive Material Construction
- Compatibility with all **Micro Fence**® Edge Guides, Circle Jigs, and all other accessories

## Cleaning and Maintenance

Your **Micro Fence**® Plunge Base has been thoroughly checked during its assembly for smooth and accurate operation. To insure this level of performance, a minimal maintenance program is advised.

We use Dynaglide Dry Lubricant to clean and lubricate the plunge posts (as well as the guide shafts on all **Micro Fence**® Edge Guides and Circle Jigs). It's a silicone-free wax and cleaner that leaves no stain on wood, tends not to build up and is easy to apply in its spray can form. If you can't locate it elsewhere, Dynaglide is available from us directly. **DO NOT** use oil on the plunge mechanism.

The micrometer dial is lubed at the time of assembly with Phil's Tenacious Oil, (we've included a 5cc sample bottle), which is also available from us in 4oz. bottles. One drop every now and then helps protect the silky smooth turning feel of the spindle.

A compressed air "shower" after each and every use goes a long way to keeping the initial feel of the tool intact.

If you wish to adjust the "feel" of the micrometer dial, you can do so by increasing or relieving the compression of the wave washer located between the two delrin washers under the gold-colored lock-nut (#). The locknut requires a 7/16" wrench. The more tightly compressed the wave washer is, the stiffer the feel of the spindle as it turns. If excessively loosened, lateral deflection of the turret stop rod (#88) is possible. As a rule, the nylock nut should be kept as tight as possible without making the spindle uncomfortably difficult to turn with your thumb and forefinger.



## The Ball-Tip Allen Screwdriver

We wanted a maintenance tool that satisfied both the torque and comfort requirements we'd prefer. The 1/8" ball-tip allen screwdriver that comes with your Mill fits everything that needs to be tightened, removed or changed. You'll find **two brass-tipped set screws** to hold the motor, **nylon-tipped set screws** for the LED mount positions, the **three plastic sub-base flat head stainless screws**, the **turret center post**, **four brass-tipped sets** for the Edge Guide/Circle Jig mounts and **two shoulder bolts** for the Auto-Centering Bearings all use the same 1/8" allen drive.

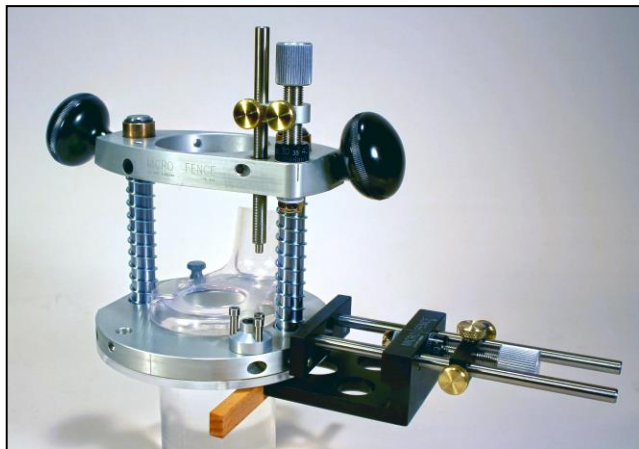

Adapter rings are available for various trimmer motors shown on page 8.

We'll probably be adding to the list of trimmers we fit as we discover demand levels over time. Stay in touch! The latest developments will always be available on our website listed in the header of every page of these instructions.

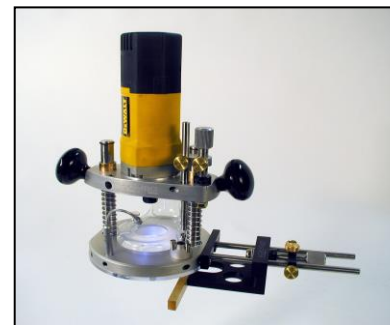

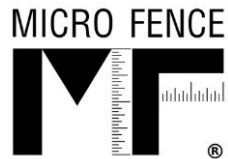

## The Portable Three-Axis Mill

12970 Branford St. Unit M, Arleta CA 91331 Phone 1-800-480-6427  
Email: [microfence@microfence.com](mailto:microfence@microfence.com) Website: [www.microfence.com](http://www.microfence.com)

### Reading Recommendations

#### **Anthony, Paul**

- **Smart Workshop Solutions-** “Building Workstations, Jigs and Accessories to Improve Your Shop” – The Taunton Press” ISBN: 1-561158-578-5

#### **Chan, Yeung**

- **Classic Joints with Power Tools-** Foreward by Frank Klausz-ISBN: 1-57990-279-0

#### **Hylton, Bill**

- **Router Magic** – Paperback, 312pp. \$18.95. Reader's Digest Association; ISBN: 0762101857
- **Hylton, Bill and Matlack, Fred** – **Woodworking with the Router**, Paperback, 344pp. \$19.95. Reader's Digest Association; ISBN 0762102276

#### **Kirby, Ian**

- **The Accurate Router, Quick Setups and Simple Jigs**, Cambrium Press, Bethel, CT, distributed by Lyons Press, NY, NY, 1998. ISBN 0-9643999-7-0

#### **Warner, Pat**

- **The Router Book, “A Complete Guide to the Router and Its Accessories”** The Taunton Press, Inc., Newtown, CT, 2001. ISBN 1-56158-423-1
- **Fast, Easy & Accurate Router Jigs**, Popular Woodworking Books, an imprint of F&W Publications, Inc., Cincinnati, Ohio, 1999. ISBN 1-55870-486-8 (alk. paper)
- **The Router Joinery Handbook**, Popular Woodworking Books, an imprint of F&W Publications, Inc., Cincinnati, OH, 1998. ISBN 1-55870-444-2 (alk. Paper)
- **Getting the Very Best From Your Router**, Betterway Books, an imprint of F&W Publications, Inc., Cincinnati, OH, 1996. ISBN 1-55870-399-3 (alk. Paper)

This Plunge Base project has been long and demanding, beyond any conceptions we had before we started. Without the help, support and friendships that have found their way here from the woodworking world, it might not have happened.

### **We would like to thank some friends who've helped us so much:**

Leroy Frieden who's machining skills have been instrumental in our design evolution. Many are the late hours we've spent altering things and anticipating the birth.

Tracy and Andy Anderson, the brothers Legacy, have gone beyond any ordinary call to friendship. Tracy with his tireless positive energy, Andy for his unusually objective common sense, and both for their more than gracious support in all matters **Micro Fence**

Chris Carlson from Bosch who's guided us generously through the search for dust collection answers.

Yeung Chan for his design sense and simply because he's him.

Pat Warner for sharing his extensive knowledge of plastics and for having his own opinion.